

SPECIFICATION FOR APPROVAL

REF :

PAGE: 1

PROD. NAME	SMD COMMON-MODE CHOKE	ABC'S DWG NO.	SC502513942□-□□□
		ABC'S ITEM NO.	

I . MECHANICAL DIMENSIONS :

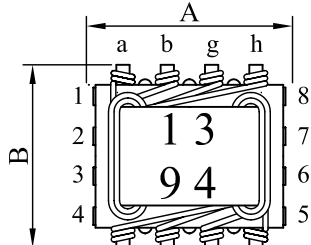

- A : 5.00±0.30 m/m
- B : 5.00±0.30 m/m
- C : 2.50±0.20 m/m
- D : 3.20 typ. m/m
- E : 0.80 typ. m/m
- F : 0.40 typ. m/m

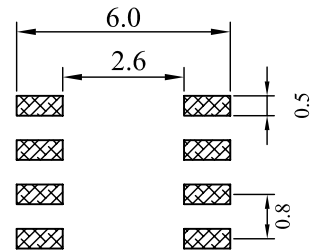
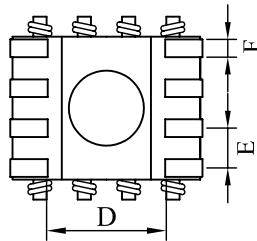
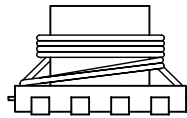
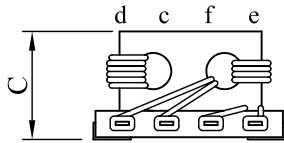

(PCB Pattern)

II . SCHEMATIC DIAGRAM :

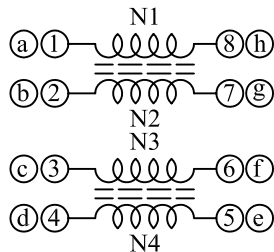

III . COMMON MODE TEST CIRCUIT :

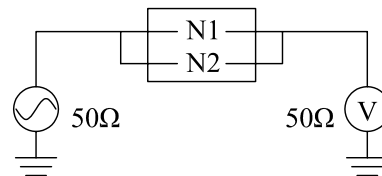

IV . MATERIALS :

- a. Core : Ferrite RID core
- b. Base : Phenolic
- c. Wire : Enamelled copper wire (class F)
- d. Adhesive : Epoxy resin
- e. Terminal : Cu/Ni/Sn
- f. Remark : Products comply with RoHS' requirements

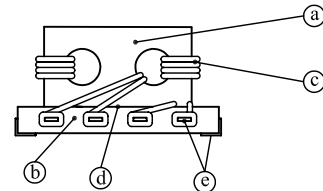

V . ELECTRICAL CHARACTERISTICS :

Insertion Loss	Freq.	Impedance	RDC (mΩ)
2.5dB±1.0dB	50MHz	180Ω(typ.) at 100MHz	50.0 typ.
8.0dB±1.5dB	100MHz		
13.0dB±2.0dB	300MHz		
15.0dB±2.5dB	500MHz		

SPECIFICATION FOR APPROVAL

REF :

PAGE: 2

PROD. NAME	SMD COMMON-MODE CHOKE	ABC'S DWG NO.	SC502513942□-□□□
		ABC'S ITEM NO.	

VI . INSERTION LOSS VS. FREQUENCY & IMPEDANCE VS. FREQUENCY :

CH1 S21&M LOG 2 dB/REF 0dB

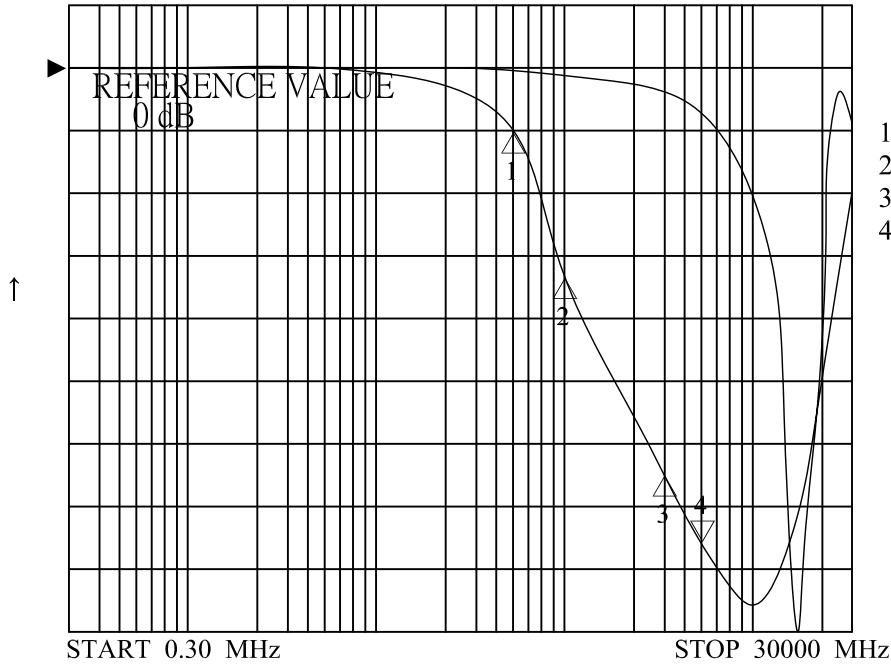

CH1 | Z | T & B 1 kΩ, 1Ω

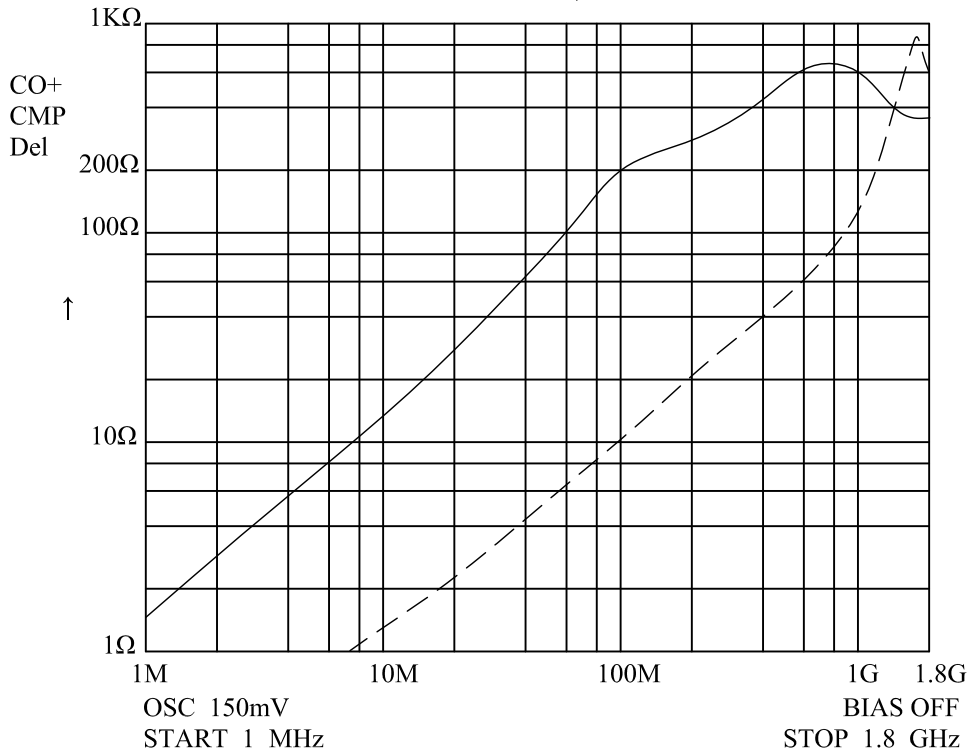

AR-001A

SPECIFICATION FOR APPROVAL

REF :

PAGE: 3

PROD. NAME	SMD COMMON-MODE CHOKE	ABC'S DWG NO.	SC502513942□-□□□
		ABC'S ITEM NO.	

VII . PACKAGING INFORMATION :

(1) Configuration

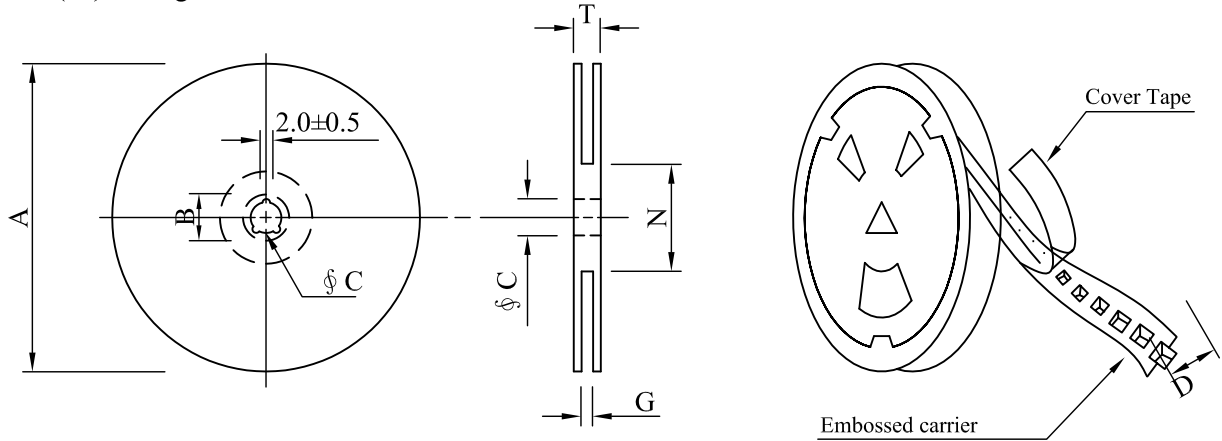

※Carrier tape width : D

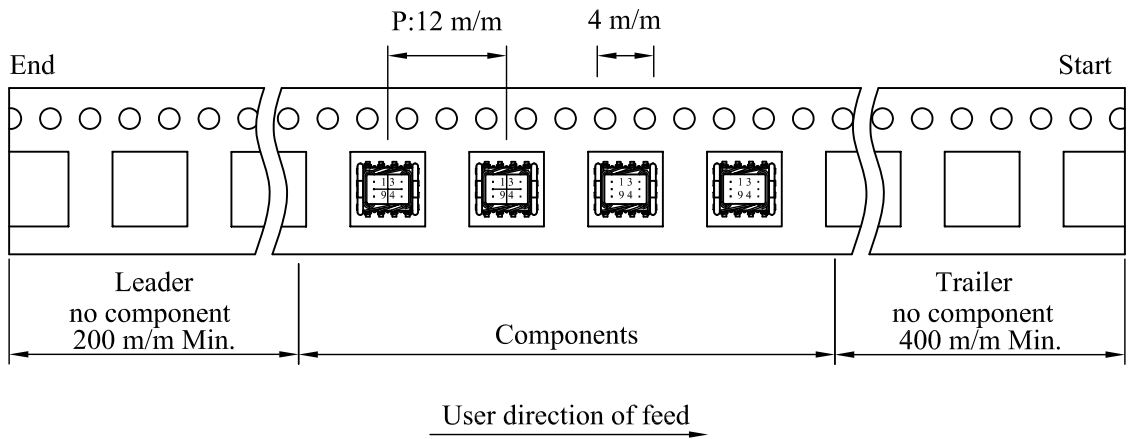

(2) Dimensions

Unit:m/m

Style	A	B	C	D	G	N	T
13 - 16	330	21±0.8	13±0.5	16	18 ⁺⁰	50 ⁻⁰	22.4

(3) Q'TY & G.W. Per package

Series	Inner : Reel			Outer : Carton		
	Q'TY (pcs)	G.W. (gw)	Style	Q'TY (pcs)	G.W. (Kg)	Size (cm)
SC5025	1,500	270	13 - 16	9,000	3.5	40 x 40 x 24

SPECIFICATION FOR APPROVAL

REF :

PAGE: 4

PROD. NAME	SMD COMMON-MODE CHOKE	ABC'S DWG NO.	SC502513942□-□□□
		ABC'S ITEM NO.	

VIII . DWGING NUMBER EXPRESSION :

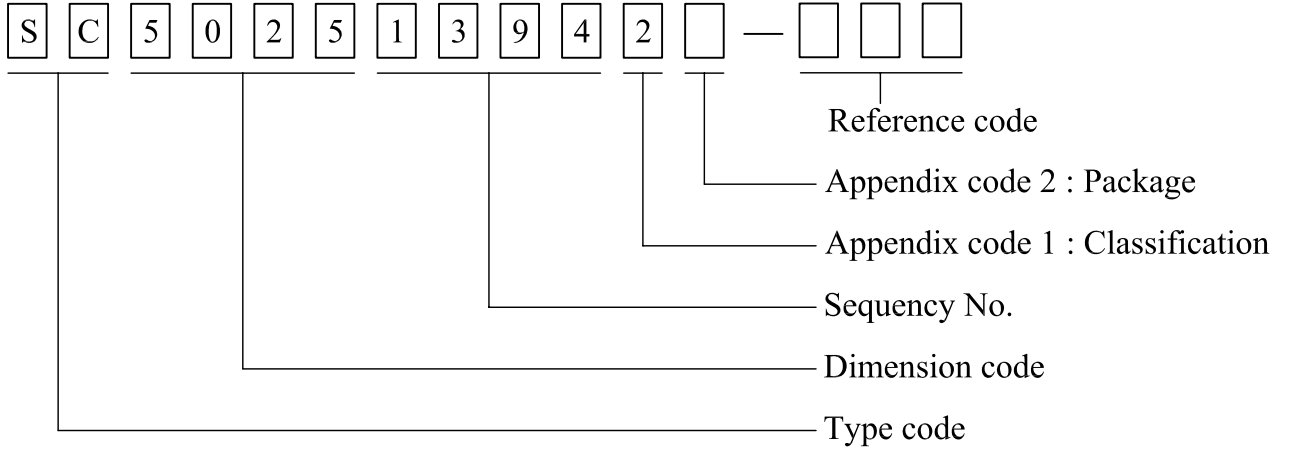

Appendix code 1 : Product Classification

- L : Lead Free Standard products comply with RoHS' requirements
- 1 ~ 9 : Lead Free Special products comply with RoHS' requirements

Appendix code 2 : Package Information

Code	Inner package	Inner package Q'TY	Remark
A	T.B.D.	T.B.D.	
B	T / R (Reel package)	1500 pcs	

SPECIFICATION FOR APPROVAL

REF :

PAGE: 5

PROD. NAME	SMD COMMON-MODE CHOKE	ABC'S DWG NO. ABC'S ITEM NO.	SC502513942□-□□□
---------------	-----------------------	-------------------------------------	------------------

IX . UL CARD :

OBMW2 September 8, 2000
Magnet Wire-Component

JUNG SHING WIRE CO LTD E174837
231 CHUNG CHENG RD, SEC 3 JEN-TEH HSIANG, TAINAN
HSIEN TAIWAN

Mtl Dsg	Mark Dsg	BC	Coat Typ	OC	ANSI Type	Temp Class
AIW	---	Polyamideimide		---	MW81-C	220
CFUEWB	---	Polyurethane		---	MW75C	130
EIAIW	---	Polyesterimide		Polyamideimide	MW35C	200
EILOCKY	---	Polyesterimide		Polyamide	---	180
EILOCKW	---	Polyesterimide		Modified Epoxy	---	200
EIW	---	Polyesterimide		---	---	220
EIW-2	---	Polyesterimide		---	MW74-C	200
FL.EILOCKY	---	Modified Polyester		Polyamide	---	155
LSFFW	---	Polyurethane		---	MW79-C	155
LSUEW	---	Polyurethane		---	---	130
PEW	---	Polyester		---	---	155
PEY	---	Polyester		Nylon	MW24-C	155
SF.FLW	---	Modified Polyester		---	MW26C	155
SF.EIW	---	Polyesterimide		---	MW77C	180
SF.BY@	---	Modified Polyester		Nylon	MW27-C	155
SF.FLY@	---	Modified Polyester		Nylon	MW27-C	155
SF.BLOCKBS	---	Modified Polyester		Modified Polyamide	---	155
SF.EILOCKY#	---	Polyesterimide		Polyamide	---	180
SF.EILOCKBS	---	Polyesterimide		Modified Polyamide	---	180
SF.BW@	---	Modified Polyester		---	MW26C	155
SFFW	---	Polyurethane		---	MW79	155

287806002 Page 1 of 2

A not-for-profit organization
dedicated to public safety and
committed to quality service

Mtl Dsg	Mark Dsg	BC	Coat Typ	OC	ANSI Type	Temp Class
SFFY	---	Polyurethane		Polyamide	MW80C	155
UEW-1	---	Polyurethane		---	MW2-C	105
UEW-2	---	Polyurethane		---	---	130
UEW-4	---	Polyurethane		---	MW75C	130
UEY	---	Polyurethane		Nylon	MW28-C	130
UEY-2	---	Polyurethane		Polyamide	MW28-C	130

@-May be suffixed by LZ; # - May be suffixed by LZ, EL or LZI.
LZ - Signifies magened wires twisted together; EL - signifies base coated magnet wire laid parallel with top coat applied overall; LZL - signi-
fies base coated magnet wire twisted together and covered with top coat overall.

Marking: Company name or trademarks JSW or 榮星電線 , material designation or marked designation on packaed or reel, and
Recognized Component Mark.

See General Information Preceding These Recognitions
For use only in equipment where the acceptability of the combination is determined by Underwriters Laboratories Inc.

287806002 Page 2 of 2

OBMW2/E174837
September 8, 2000

AR-001A

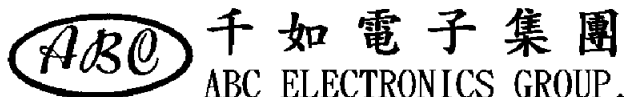

SPECIFICATION FOR APPROVAL

REF :

PAGE: 6

PROD. NAME	SMD COMMON-MODE CHOKE	ABC'S DWG NO.	SC502513942□-□□□
		ABC'S ITEM NO.	

SUMITOMO CHEMICAL CO LTD										E54705 (M)	
5-33 KITAHAMA 4-CHOME CHUO-KO, OSAKA JAPAN											
Mtl Dsg	Col	Min Thk mm	UL94 Flame Class	Elec	RTI		H W I	H A I	H V T R	D 4 9 5	C T I
					with Imp	w/o Imp					
Liquid crystal polyester (LCP), designated "EKONOL" or "SUMIKASUPER", furnished in the form of pellets, (Contd)											
E4008 , E400X	NC , BK	0.30	94V-0	130	130	130	—	—	—	—	—
		0.75	94V-0	130	130	130	3	4	—	—	—
		1.5	94V-0	130	130	130	2	4	—	—	—
		3.0	94V-0	130	130	130	1	4	0	5	4
E4008	NC , WT , BK	0.30	94V-0	130	130	130	—	—	—	—	—
		0.75	94V-0	220	180	220	3	4	—	—	—
		1.5	94V-0	220	200	240	2	4	—	—	—
		3.0	94V-0	220	200	240	1	4	0	5	4
E4010	NC , BK	0.30	94V-0	130	130	130	—	—	—	—	—
		0.75	94V-0	220	180	220	3	4	—	—	—
		1.5	94V-0	220	200	240	2	4	—	—	—
		3.0	94V-0	220	200	240	1	4	0	5	4
E400(Y)L , E4008L	NC , BK	0.30	94V-0	130	130	130	—	—	—	—	—
		0.75	94V-0	130	130	130	3	4	—	—	—
		1.5	94V-0	130	130	130	2	4	—	—	—
		3.0	94V-0	130	130	130	1	4	0	5	4
E4810	NC , BK	0.30	94V-0	130	130	130	—	—	—	—	—
		0.75	94V-0	130	130	130	0	4	—	—	—
		1.5	94V-0	130	130	130	0	4	—	—	—
		3.0	94V-0	130	130	130	1	4	0	5	4

(X) Denotes any number 1 thru 9.
(Y) Denotes any number 1 thru 7.

AR-001A

